

OPPO P/N: 9770322

REV	ECN NO.	DESCRIPTION	DATE	APPD
A		工程变更	2017.02.07	曹林江
B	PCN1705002	Add Dim39#, Update Unmating Force 10N.	2017.05.04	曹林江
C	PCN1706005	Up Date Terminal Plating Specifications.	2017.06.27	曹林江

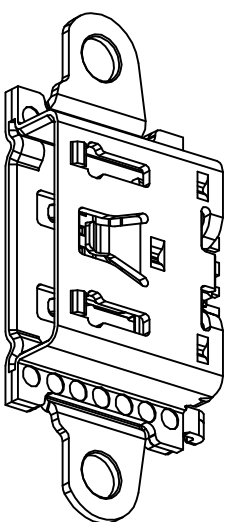

3D VIEW

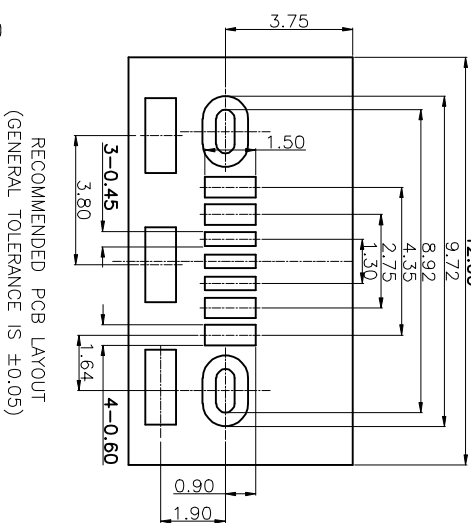
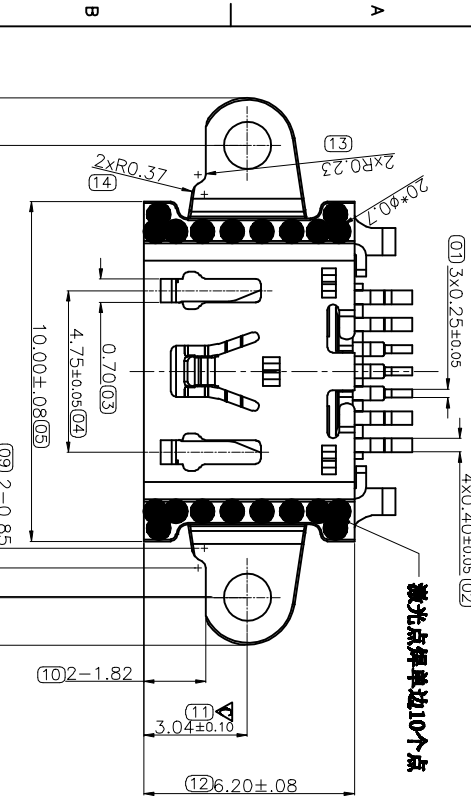
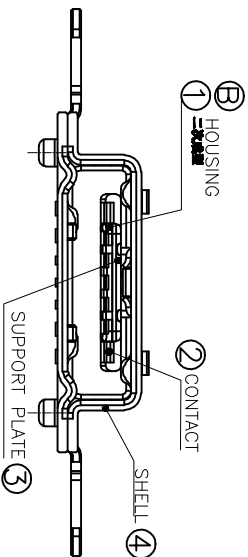
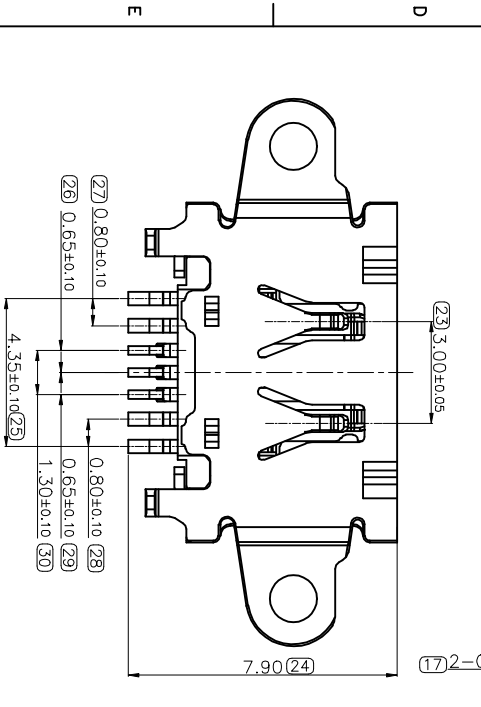
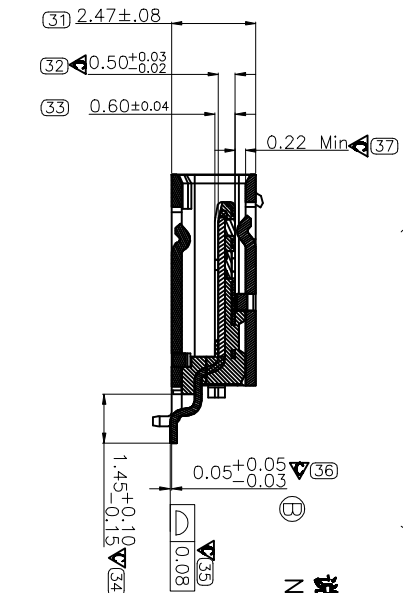
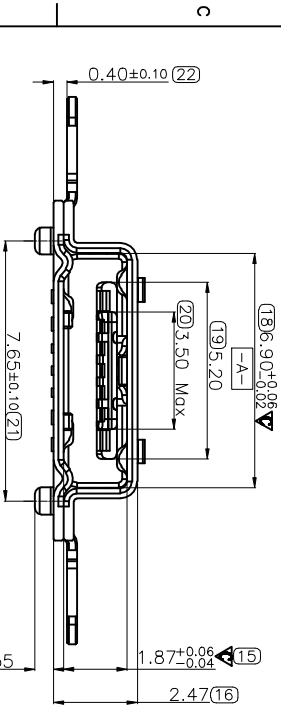

ITEM	PART NAME	PART NO.
④	SHELL	3.089S3-000-SR6
③	SUPPORT PLATE	3.089S0-000-NR6
②	CONTACT	3.089T0-007-7RH
①	HOUSING	3.089M1-007-7R1

说明:

- 1. 物料材料: PA10T, 颜色: BLACK;**  
 HOUSING MATERIAL: PA10T, COLOR: BLACK;  
 端子材料: 镍锡, 镀层50~120u", 接触区镀金30u", 焊脚面镀金2u", 反面1u";  
 CONTACT MATERIAL: NICKEL AND COPPER;  
 NICKEL 50~120u" UNDER PLATED OVER ALL;  
 30u" MIN. GOLD PLATED AT CONTACT AREA;  
 20" Min. REVERSE 1U" GOLD PLATED AT CONTACT AREA;  
 物料材料: 不锈钢, 镀层50~120u";  
 SUPPORT PLATE MATERIAL: STAINLESS STEEL, PLATED NICKEL 50~120u";  
 外壳材料: 不锈钢, 镀层50~120u"; 轴上镀层50~150u";  
 SHELL MATERIAL: STAINLESS STEEL,  
 NICKEL 50~120u" UNDER PLATED OVER ALL;  
 MATTE TIN 80~150u" ON THE ALL.
  - 2. 产品性能:**
    - 2.1 性能:**  
 2.1.1 耐电压: 使用交流电压100V, 电流1mA, 保持1分钟.  
 Applied AC 100V for 1 minute 1mA
    - 2.2 接触电阻:** 40m Ohm Max.  
 CONTACT RESISTANCE: 40mOhm Max.
    - 2.3 绝缘电阻:** 1000 Ohm Min.  
 INSULATION RESISTANCE: 100MOHM Min.
    - 2.4 插入力:** 插入力最大值, 拔出力最大值.  
 MATING AND UNMATING FORCE:  
 MATING FORCE: 25N Max, UNMATING FORC: 10N Min.  
 DURABILITY: 10000 CYCLES
- 注: 标注▽的为成型尺寸; 标注( )的尺寸为关键尺寸; 标注FAI的为尺寸公差.  
 MARK ▽ THE KEY SIZE, MARK ( ) FAI.

EXTEND USE		TITLE		DWG NO
MICRO USB CONNECTOR WITH SUPPORT PLATE		MICRO USB CONNECTOR MANUFACTURER DRAWING		
GENERAL TOLERANCE	⑩	UNIT	mm	C-3.089A5
DIMENSION	±0.30	MATERIAL	镀锌钢 2017.06.26	P/N:
ANGLES	±3°	APPD	曹林江 2017.06.27	3.089A5-007-7R0
	±0.20	QTY	1	SHEET
	±0.15	CHD	曹林江	1/1
	±0.10	FINISHED	涂漆	SCALE
	±0.08	DRN	汪杰	1:1
		DRN	汪杰	REV
			2017.06.27	C

